



**Feature :**

- Compact size
- Reflow soldering available

**Application :**

- Consumer products
- Computer products
- Instrumentation
- Communication equipments
- Hand-held devices

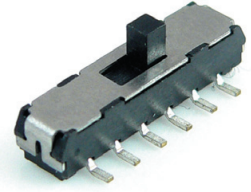

SWITCH SPECIFICATIONS	
POLE - POSITION	4P2T
CONTACT RATING	6 V DC , 0.3 A
CONTACT RESISTANCE	70 mΩ MAX. 5 V DC ; 1 A , by Method of Voltage DROP
INSULATION RESISTANCE	100 MΩ MIN. 500 V DC for 1 minute
DIELECTRIC STRENGTH	Breakdown is not Allowable ; 500 V AC for 1 Minute
OPERATING FORCE	200 ± 150 gf
OPERATING LIFE	10,000 cycles
OPERATING TEMPERATURE RANGE	-40°C ~ 85°C
TOTAL TRAVEL	2.0 ± 0.3 mm

**▶ HOW TO ORDER**

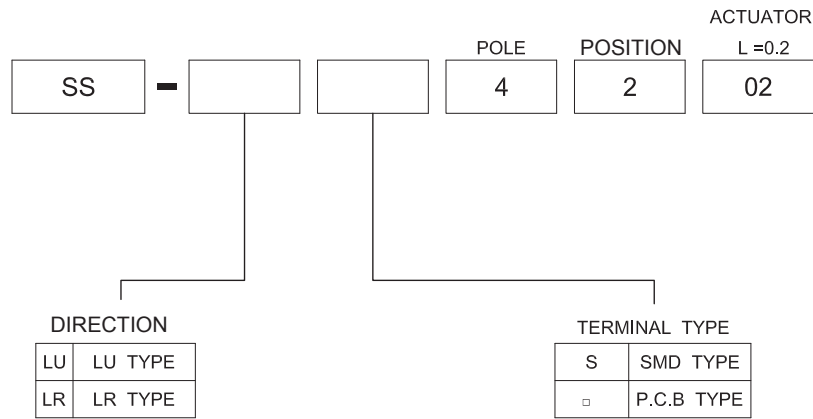



► DIMENSION

SS-LUS4202

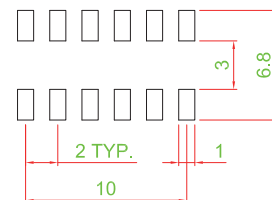
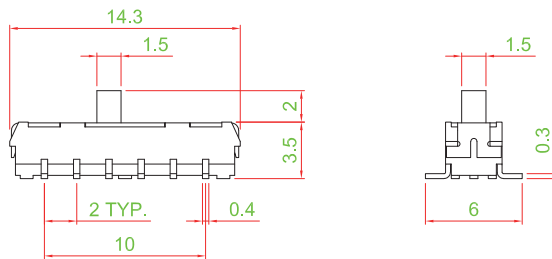
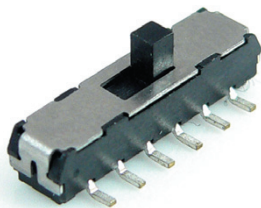

SS-LRS4202

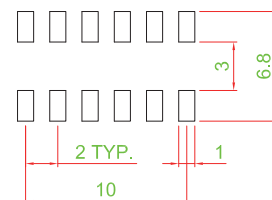
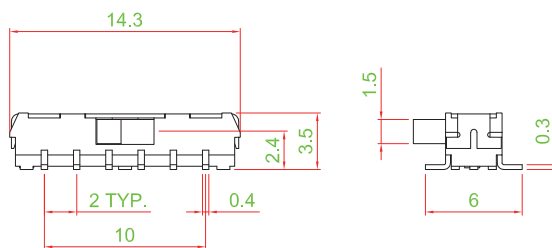
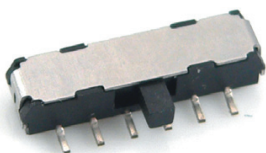

SS-LU4202

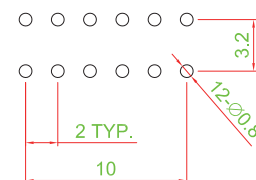
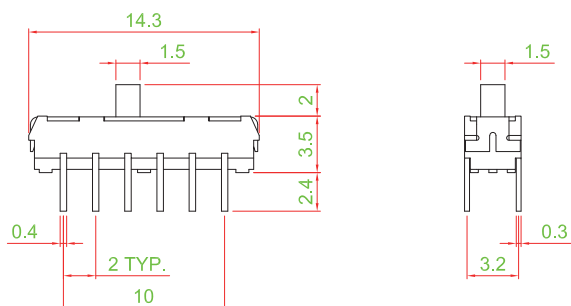
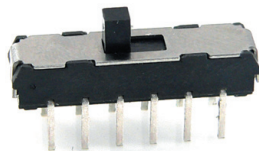

SS-LR4202

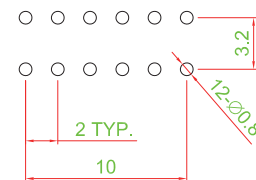
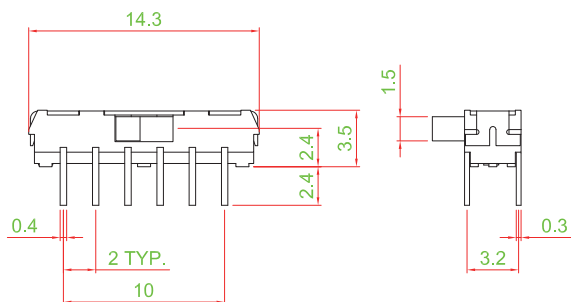
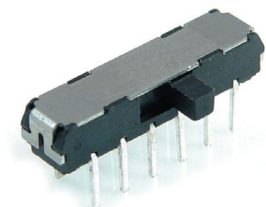

► CIRCUIT

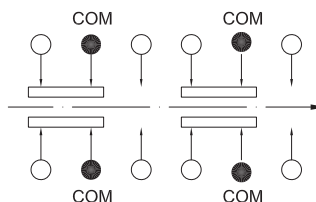

- TACT SWITCH
- PUSH BUTTON SWITCH
- LED TOUCH SENSOR SWITCH
- 5 DIRECTION NAVIGATION SWITCH WITH LED
- MEMBRANE SWITCH
- LED LIGHT BAR
- SLIDE SWITCH
- ROTARY SWITCH
- ROCKER SWITCH
- DETECT SWITCH
- ENCODER
- INTERRUPTER
- MINIATURE MICRO SWITCH
- TELEPHONE HOOK SWITCH
- DOOR SWITCH
- MINI SIZE SOCKET
- KNOB
- CAP SYMBOL