



Feature :

- Bi-color LED illuminated available
- SPST, DPDT
- Lock / non-lock function

Application :

- Audio / video products
- Instrumentation
- Communication equipments



SWITCH SPECIFICATIONS	
POLE - POSITION	SPST , DPDT
CONTACT RATING	30 V DC , 0.1 A
CONTACT RESISTANCE	50 mΩ MAX. 1.5 V DC ; 100 mA , by Method of Voltage DROP
INSULATION RESISTANCE	100 MΩ MIN. 500 V DC for 1 minute
DIELECTRIC STRENGTH	Breakdown is not Allowable ; 500 V AC for 1 Minute
OPERATING FORCE	250 ± 100 gf
OPERATING LIFE	100,000 cycles
OPERATING TEMPERATURE RANGE	-40°C ~ 85°C
TOTAL TRAVEL / LOCK TRAVEL	2.5 ± 0.3 mm / 1.5 ± 0.3 mm

LED SPECIFICATIONS								
ATTENTION LEDs are Electrostatic Sensitive devices 	Unit	Value / LED Color						
		Blue	Pure Green	Red	Yellow	Orange	Green	White
LUMINOUS INTENSITY@20mA Iv	mcd	900	6500	900	1300	900	400	1200
Dominant Wavelength λD	nm	470	525	635	590	601	570	/
FORWARD VOLTAGE@20mA Vf	V	3.2	3.3	1.95	2	2.1	2.1	4

■ A single bin cannot be ordered, please contact us in advance if you need a particular bin sorting before placing your order to clarify the lead time, MOQ and pricing

▶ HOW TO ORDER

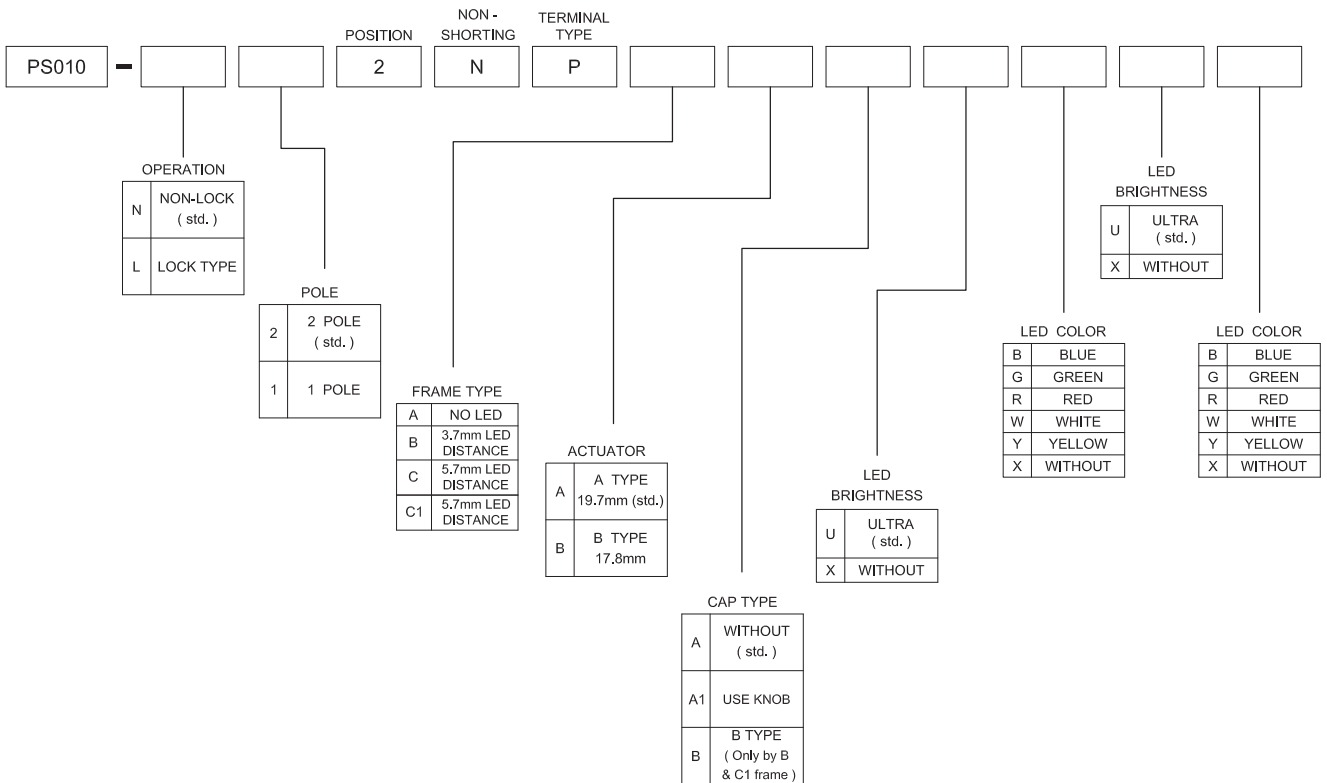



► **DIMENSION**

PS010 - N22NPABAXXXX

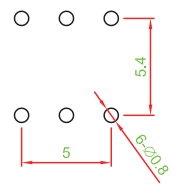
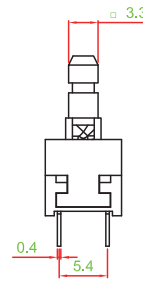
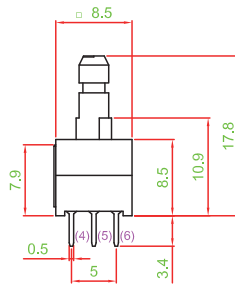

PS010 - N22NPBAA □ □ □ □

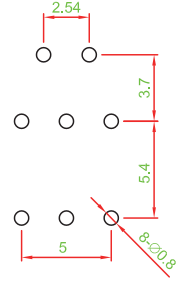
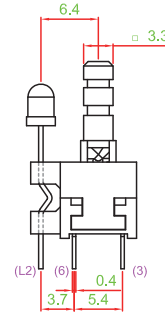
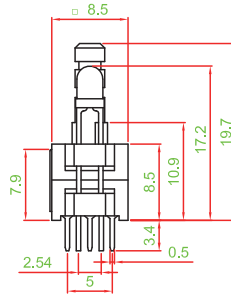
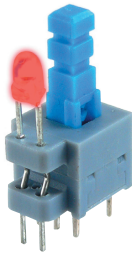

PS010 - N22NPCAA □ □ □ □

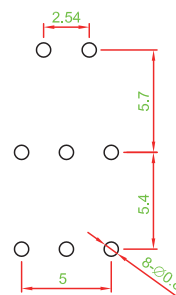
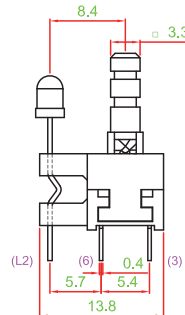
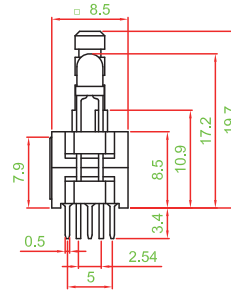
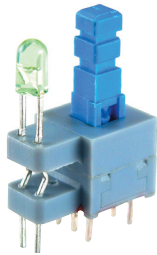

PS010 - N22NPC1AA □ □ □ □

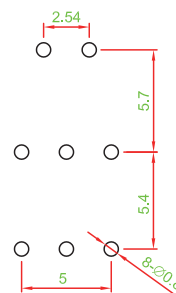
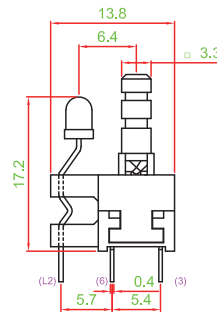
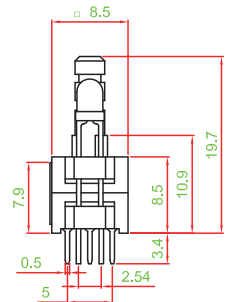

► **CAP TYPE**

B TYPE :



► **CIRCUIT**

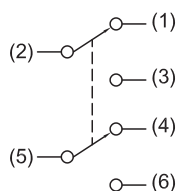

SINGLE COLOR



TWO COLOR

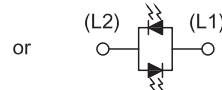

- TACT SWITCH
- PUSH BUTTON SWITCH
- LED TOUCH SENSOR SWITCH
- 5 DIRECTION NAVIGATION SWITCH WITH LED
- MEMBRANE SWITCH
- LED LIGHT BAR
- SLIDE SWITCH
- ROTARY SWITCH
- ROCKER SWITCH
- DETECT SWITCH
- ENCODER
- INTERRUPTER
- MINIATURE MICRO SWITCH
- TELEPHONE HOOK SWITCH
- DOOR SWITCH
- MINI SIZE SOCKET
- KNOB
- CAP SYMBOL